

Traction machine related parameters		
Rated speed (m/s)	0.5	1.0
Product type of traction machine	GEMT6.0H GEMT8.0H	
Traction machine power (KW)	15.3	33.4
Rated current (A)	37.5	70
Start-up current (A)	75	140

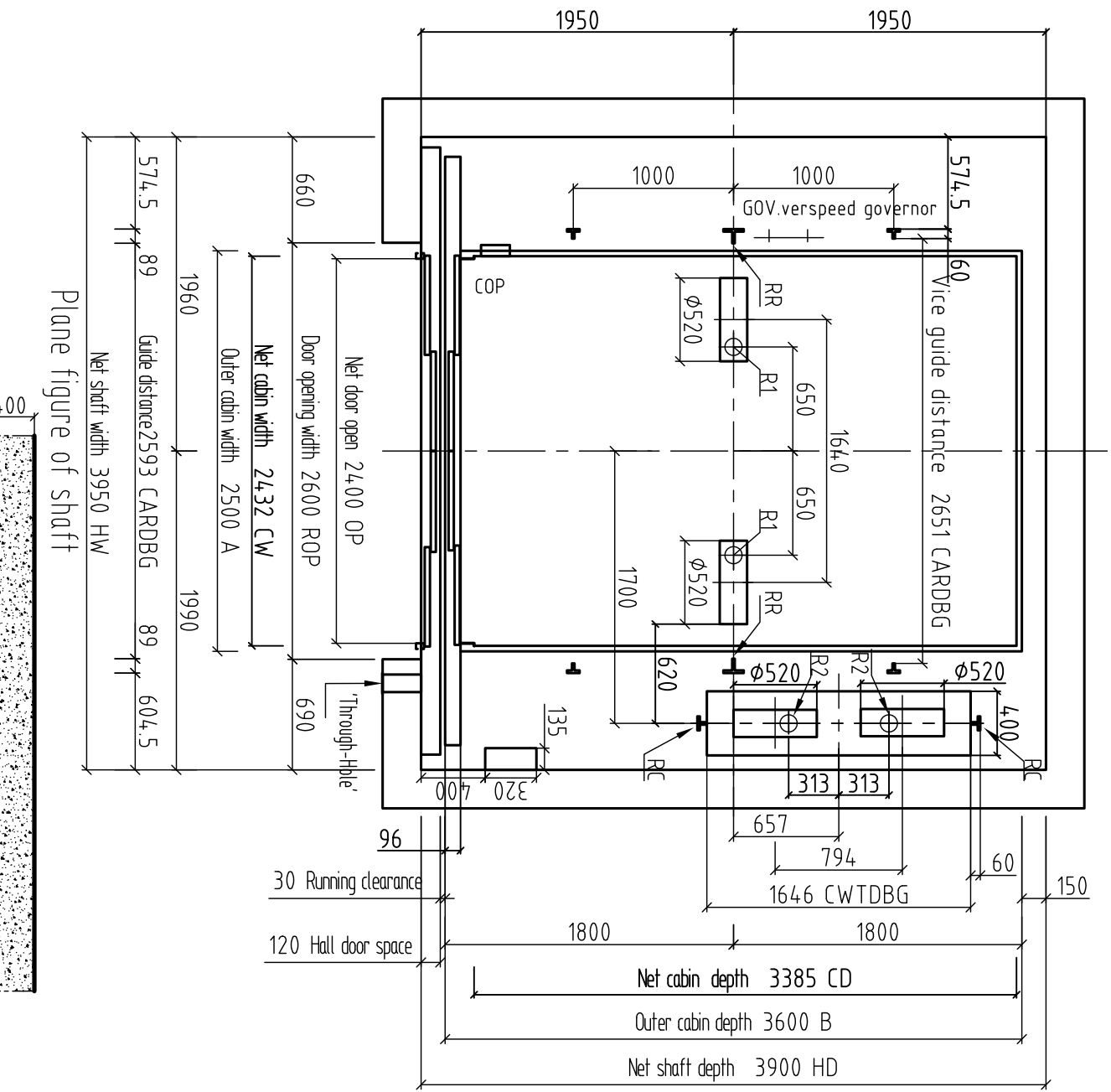
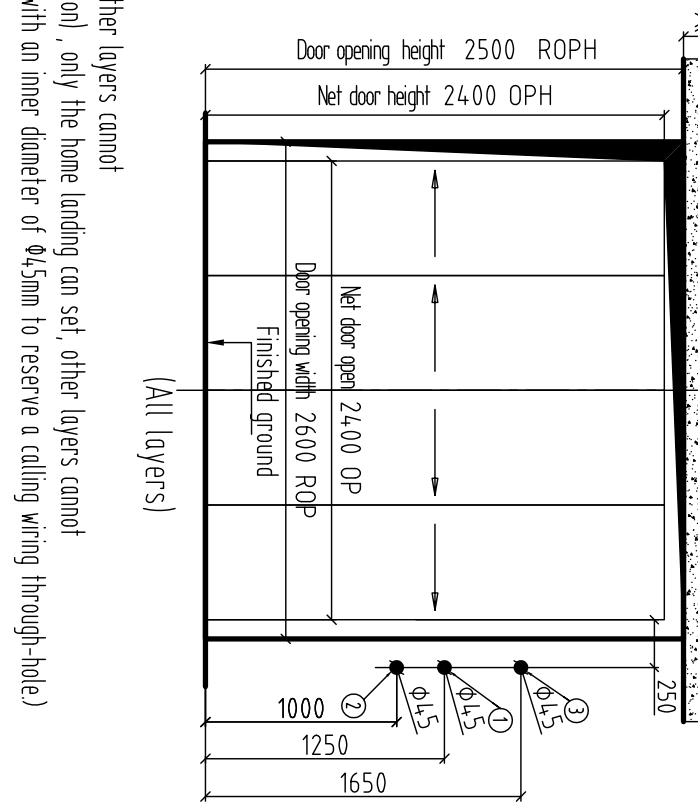

Force of guide rail:	$F_x =$
	$F_y =$

Technical parameters	
Elevator model	CL200 SE
Load	5000kg
Speed	0.5, 1.0 m/s
Rope speed ratio	4:1
Control mode	Microcomputer
Opening mode	Center open four panel
Minimum floor distance(mm)	OPH+650
Power supply	380V TN-S 50HZ
Light and signal power supply	220V 50HZ

The following should be filled out carefully by the user

Shaft structure	Fixed mode of rail brackets (user check)
Brick wall	Pre-embedded slab <input type="checkbox"/> Foreseen hole <input type="checkbox"/>
Cement concrete	Expansion bolt <input type="checkbox"/> Pre-embedded slab <input type="checkbox"/>
Brick wall + perimeter beam	Expansion bolt <input type="checkbox"/> Foreseen hole <input type="checkbox"/>
Steel-shaft structure	Welding bracket <input type="checkbox"/>

Drawing confirmation: the user unit fully agrees to manufacture according to the specifications of this drawing

Confirm: _____
Date: _____

Change at: _____

Name	Date	Change situation

Project name: _____

Contract No: _____

Civil engineering No:	
Drawing:	
Verification:	
Confirm:	
Date:	

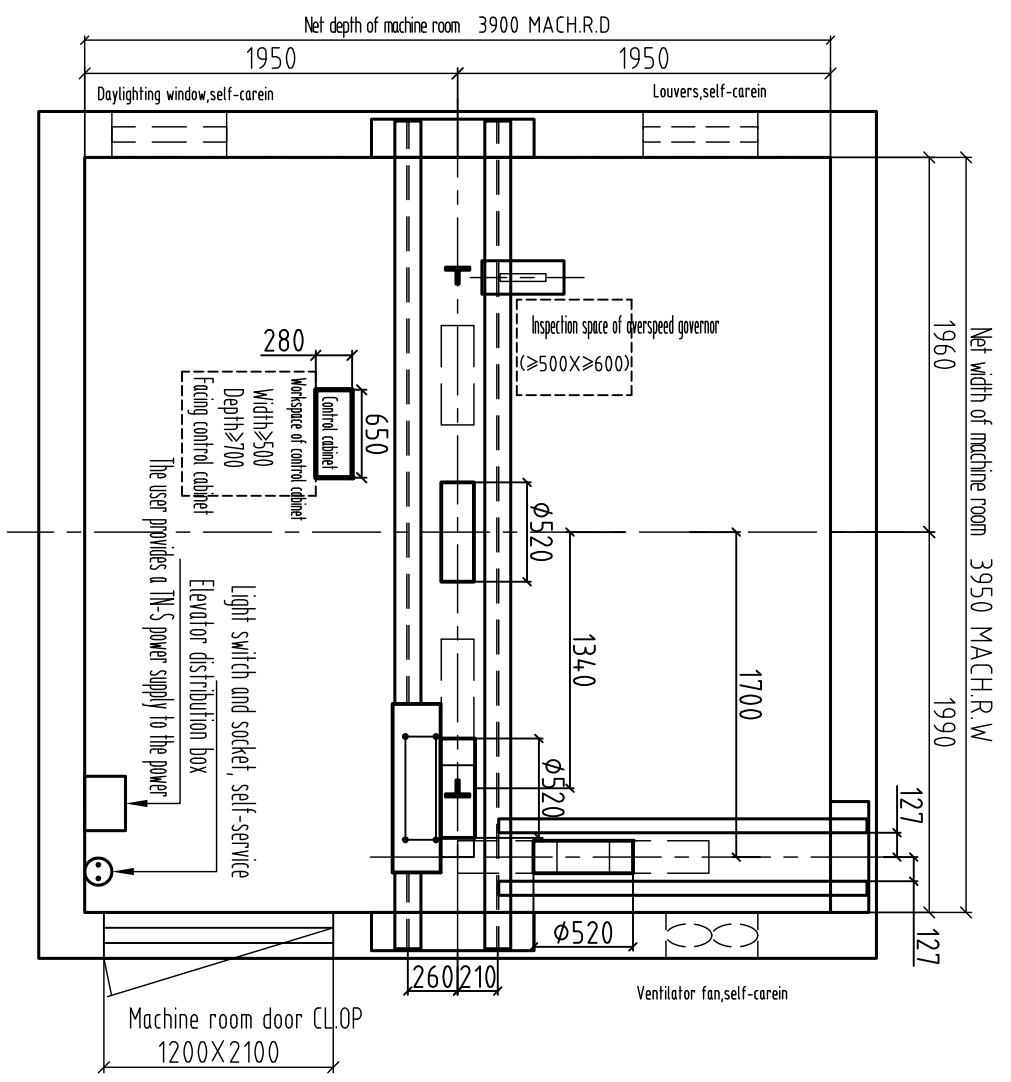

Plane figure of machine room

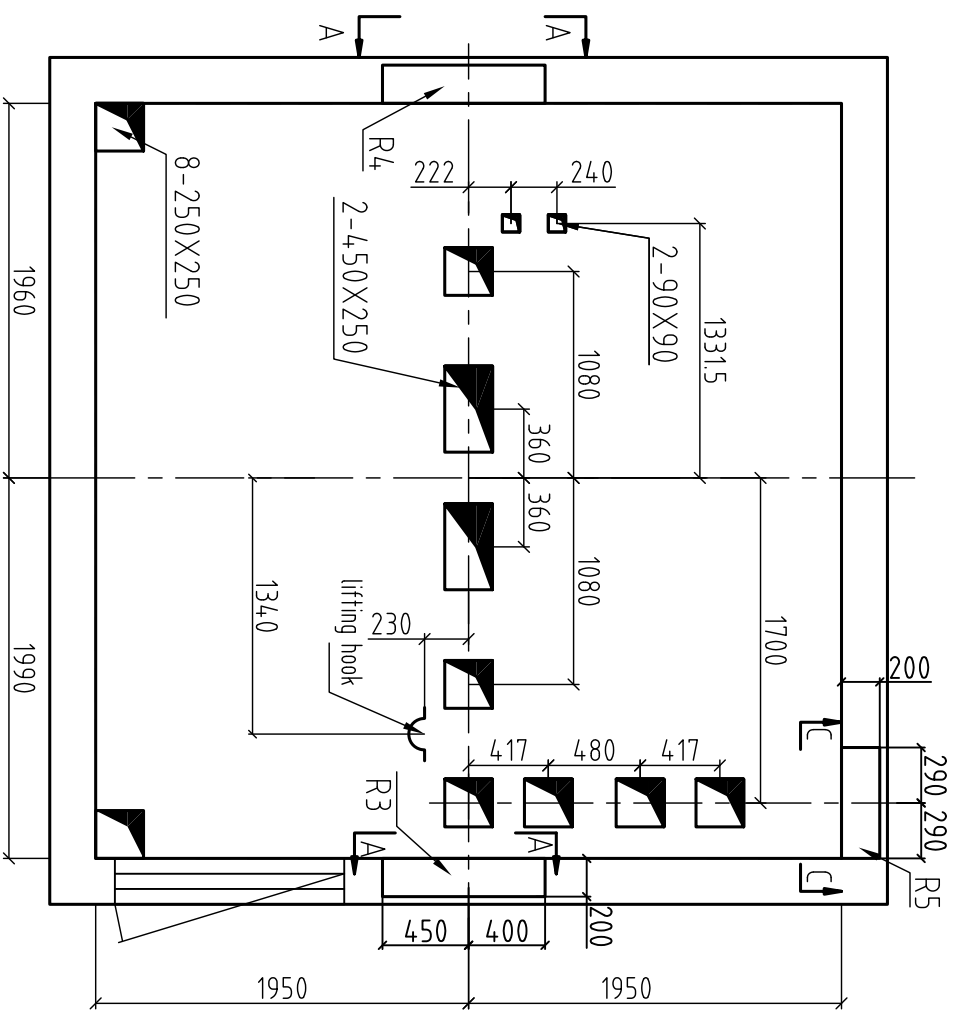

Foreseen hole diagram of machine room

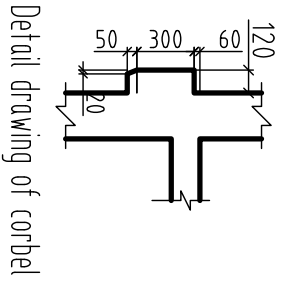

Detail drawing of corbel

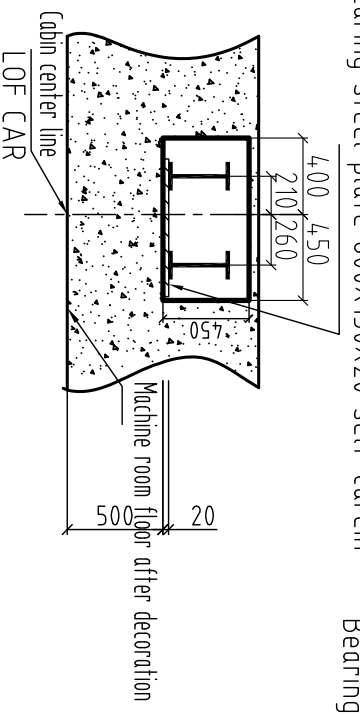

Machine room floor after decoration

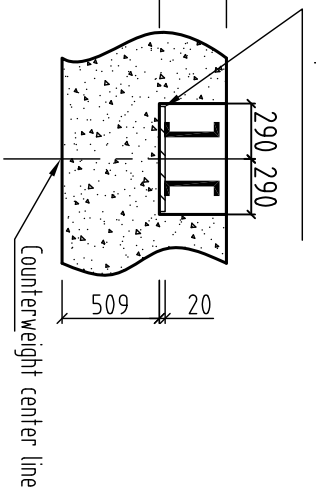

C-bearing hole

Bearing steel plate 800X150X20 self-carein

Bearing steel plate 500X150X20 self-carein

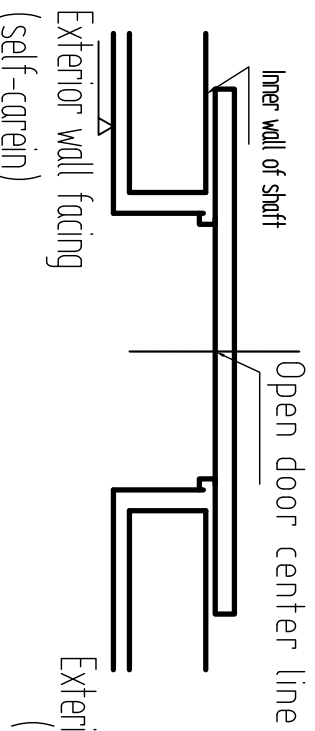

Schematic diagram of narrow door jamb

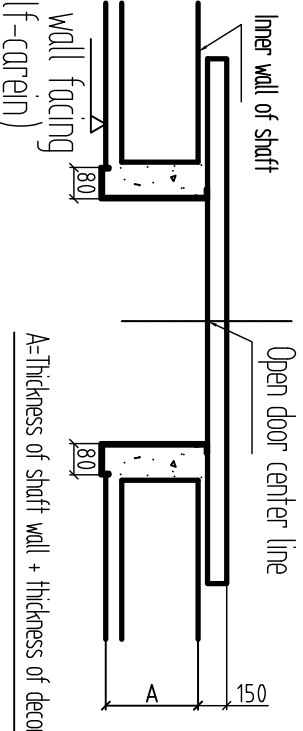

(The user provides)
Schematic diagram of wide door jamb
(The parameter table for the wide door jamb needs to be filled out during production.)

Reaction fores(KN)	
R1=	194
R2=	144
R3=	246
R4=	131
R5=	45
RR=	150.5

Technical requirements of elevator civil engineering

- All buildings in the shaft must meet the requirements of fire prevention, and shall not be installed with unattended elevator equipment, power supply, and unrelated holes.
- The shaft must be vertical, which horizontal measurement is the minimum net size, and vertical error is 0-5mm/0.3m/0.3mm/3m, 6m, 0.55mm/6m and above.
- If there is a space below the bottom of the pit that can be accessed by person, the counterweight buffer can be installed on a pier which is continuously extending to solid pier, or ask the elevator manufacturer how to install the counterweight safety gear.
- Before the installation of the elevator, all landing door openings must be equipped with safety protection fence enclosures, which height is more than 12 meters, and it should be ensured that can bear the shear forces.
- The enclosed shafts should be equipped with ventilation holes, if needed, generally at the top and bottom of the shaft, which area is not less than 1% of the horizontal area of the shaft. Protective nets should be installed on the ventilation holes.
- The reserved holes for elevator hall door, call display and others need to be backfilled and decorated after elevator installation.
- It is preferable for the elevator shaft to be made of concrete structure, if the shaft is a frame structure, the gate rail brackets should install a 30mm high concrete collar, and the upper and lower edges of hall door hole on each floor should be installed a 30mm high concrete beam with the same width as the shaft. If the shaft is a solid bearing type wall structure, and the upper and lower edges of hall door hole on each floor should be installed a 30mm high concrete beam with the same width as the shaft.
- When the distance between two adjacent hall door sills is over 11 meters, it should be set a safety door that is more than 30mm wide and 800mm high, which can't opens inward to the shaft.
- The safety door should be equipped with lock can open with a key, it can be closed and locked without a key when the door is opened, and even if locked, it should be able to be opened from the inside of the shaft without a key.
- The inner of pit should be waterproof. If there is a water pit, it should be set in the corner.
- According to the requirements of technical parameters sheet, the power supply should be set in machine room and equipped with a locked protection switch. The range of power supply fluctuations should be less than ±1%. The Neutral wire and earth line of the power supply must be separated, and the ground resistance must be less than 4Ω.
- All loads indicated in the drawing include impact corrections, unless specified. And the strength of the shaft wall and pit must be ensured that can bear the shear forces.
- The self-carein marked in the diagram (Pre-embedded steel stud, etc.) need to be present.
- The temperature in the machine room should be maintained at 5-40℃, the machine room should be hot and must be able to withstand not less than 17kN/m² per square meter that can bear the shear forces.
- User should set up a rescue dry room which give a communication cable to machine room when the cable run distance less than 500 meters need to give a six core twisted shielded wire(2X20/2mm²) when it bigger than 500 meters need to give a cat 5 cable. The standard value of the floor is uniformly distributed load.

User announcements

- Technical requirements of elevator civil engineering is the most part of civil engineering arrangement should be rigorously followed. Anything not covered in this drawing is executed according to relevant clauses of the national elevator standard GB5088-2003.
- All civil engineering works are not carried out in accordance with this Clause, the user are responsible to rework, from this the resulting consequence from the user.
- If the size of shaft need to rework, please inform us in written form timely and get our recognition before make changes.

Drawing confirmation: the user unit fully agrees to manufacture according to the specifications of this drawing

Confirm: _____

Date: _____

Change at:

Name	Date	Change situation

Project name:

Contract No:

Civil engineering No:

Drawing:	
Verification:	
Confirm:	
Date:	